

# USER MANUAL

## Smart Toilet



EWC | Multi-function Rain Shower | Shower Panel | Steam Generator  
Basin | Smart Toilet | Diverter-Mixer



smart toilet

Feel Free to Visit Our Website

[www.jaaz.in](http://www.jaaz.in)

Thank you for acquiring this innovative, useful and reliable smart appliance. You will soon be reassured that your decision to use this product was well-made.

### NOTE:

The picture in this manual are only representative drawings.

This unit was manufactured for household use.

This product should be installed according to this manual.

Please keep this manual for future reference.

Please register warranty for proper service.

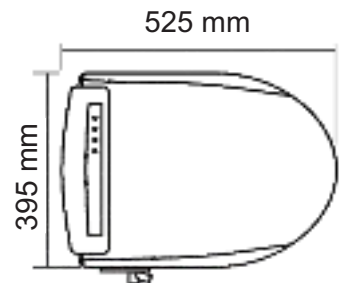

# CONTENTS

Safety Instructions .....	1
Parts & Accessories .....	3
Installation .....	5
Using The Bidet .....	7
Maintenance & Specifications .....	9
Trouble-shooting & Dismantling .....	10
Warranty Card .....	11

# FEATURES

Rear Wash Catharsis (Deep Clean) Automatic Body sensor
Ladies'/Front Wash Own Water Pump: Assured Water Pressure Massage
Nozzle Oscillation Self-Cleaning Nozzle Adjustable Water Temperature & Pressure
Warm Seat Dry Auto-Deodorization
UV Antibacterial LED Night Light Remote Control
Water Filter Energy-Saving Functions Automatic Power cut-off Slow Closing Toilet Seat & Cover
Motor Drive CPU Control Easy D.I.Y. Installation IP67 Waterproof Buttons

















The mentioned features are described further in this catalogue below.

We request you to go one by one through the features for easy and efficient use.

# SAFETY INSTRUCTIONS

The following sticker is placed on to the toilet seat cover, visible when the cover is in the open position, to serve as a constant reminder of some important do's and don'ts:

**ATTENTION**

  <p><b>Read the owner's manual carefully so as to use this appliance properly.</b></p> <p><i>Lisez bien le manuel d'utilisation pour pouvoir utiliser cet appareil correctement.</i></p>	  <p><b>The seat and cover are slow closing. Do not lower them by force.</b></p> <p><i>WC abattant avec amortisseur de fermeture. Ne pas fermer avec force.</i></p>
  <p><b>Never use lit or flammable products, near this appliance.</b></p> <p><i>N'utilisez jamais de produits allumés ou inflammables à proximité de cet appareil.</i></p>	  <p><b>Do not disassemble or repair the product. In case of need, contact the service centre.</b></p> <p><i>Ne pas démonter ou réparer le produit. En cas de besoin, veuillez contacter le centre de service.</i></p>
  <p><b>Do not pour water on any part of this product.</b></p> <p><i>Ne pas verser de l'eau sur aucune partie de ce produit.</i></p>	  <p><b>Do not stand on any part of this appliance or sit on the seat cover.</b></p> <p><i>Ne montez sur aucune partie de cet appareil et ne vous asseyez pas sur le couvercle du siège.</i></p>
  <p><b>Select low temperature for children, the elderly and the disabled.</b></p> <p><i>Sélectionnez la température basse pour les enfants, les personnes âgées et les personnes handicapées.</i></p>	  <p><b>Never use any detergent, thinner, bleach, etc. to clean this product.</b></p> <p><b>Use a soft cloth slightly moistened with water.</b></p> <p><i>N'utilisez jamais de détergent, de diluant, d'eau de javel, etc. pour nettoyer ce produit. Utilisez un chiffon doux légèrement mouillé avec de l'eau.</i></p>

## SAFETY INSTRUCTIONS

Please also note the following:

- \* Connect the bidet to a standard 3-pin earthed socket for electricity supply.
- \* Avoid touching the plug or socket with wet hands.
- \* Connect the Power Cord only after installation has been fully completed.
- \* Remove the plug from the socket whenever repairing or dismantling the bidet.
- \* Avoid connecting many plugs to the same socket outlet.
- \* If the socket and/or the plug are damaged, contact an electrician for replacement.
- \* Connect the appliance to a potable water source that is intended for household use.
- \* If the water supply in your house contains limestone, or other impurities, connect the water filter that is supplied in the accessories. This filter will need to be replaced periodically depending on the water quality in your home. The filter is not covered by our warranty.
- \* Should the bidet develop any defect, stop using it and contact the service centre immediately.
- \* Do not apply excessive force when pushing the buttons on the control panel.
- \* Do not urinate directly on the nozzle.
- \* Do not block the deodorizer air outlet vents.
- \* Do not lean back against the lid, during use, as this may damage it.
- \* Do not expose this product to direct sunlight, as it may cause the plastic parts to discolour.

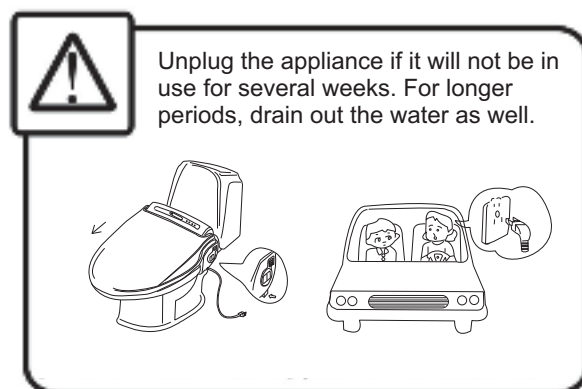
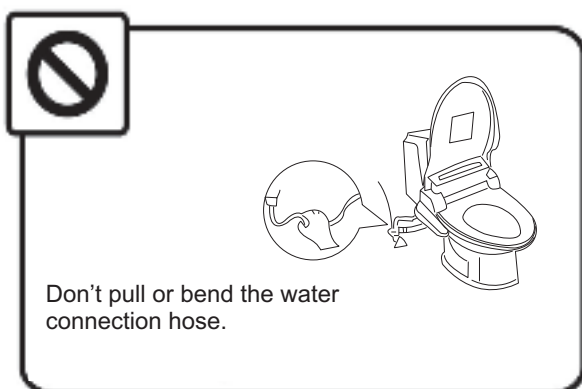

THE NON-RESPECT OF THESE SAFETY INSTRUCTIONS  
COULD RESULT IN SERIOUS DAMAGE TO  
THE APPLIANCE AND/OR INJURY TO THE USER.

# PARTS & ACCESSORIES

## COMPONENTS

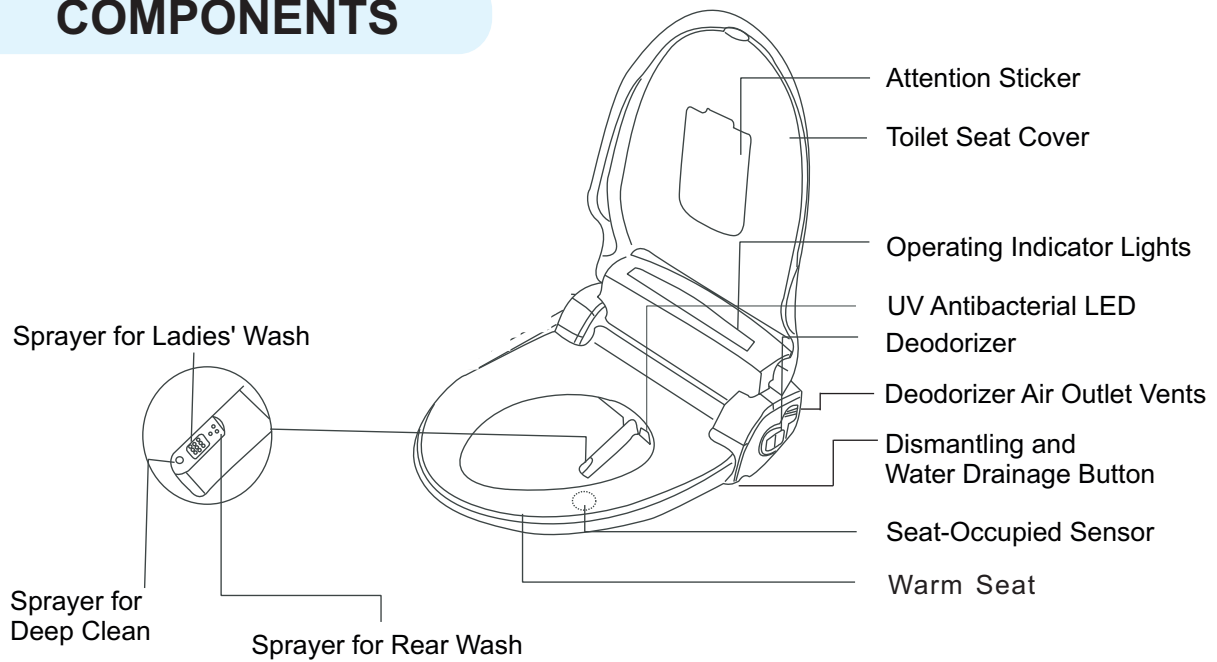

We request you to understand the product based on this image so it will be convenient to use.

## ACCESSORIES

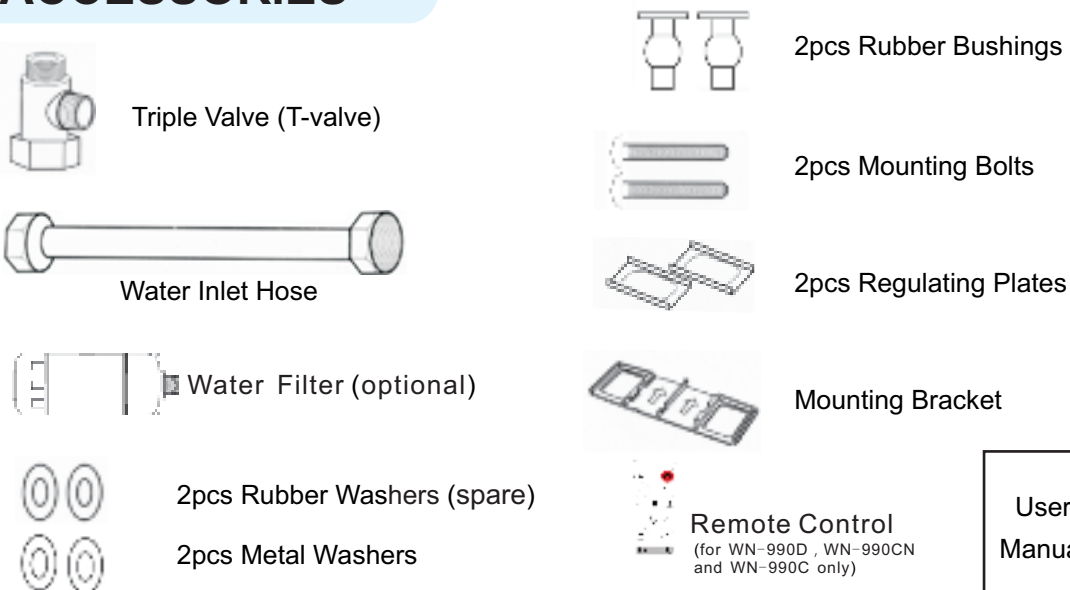



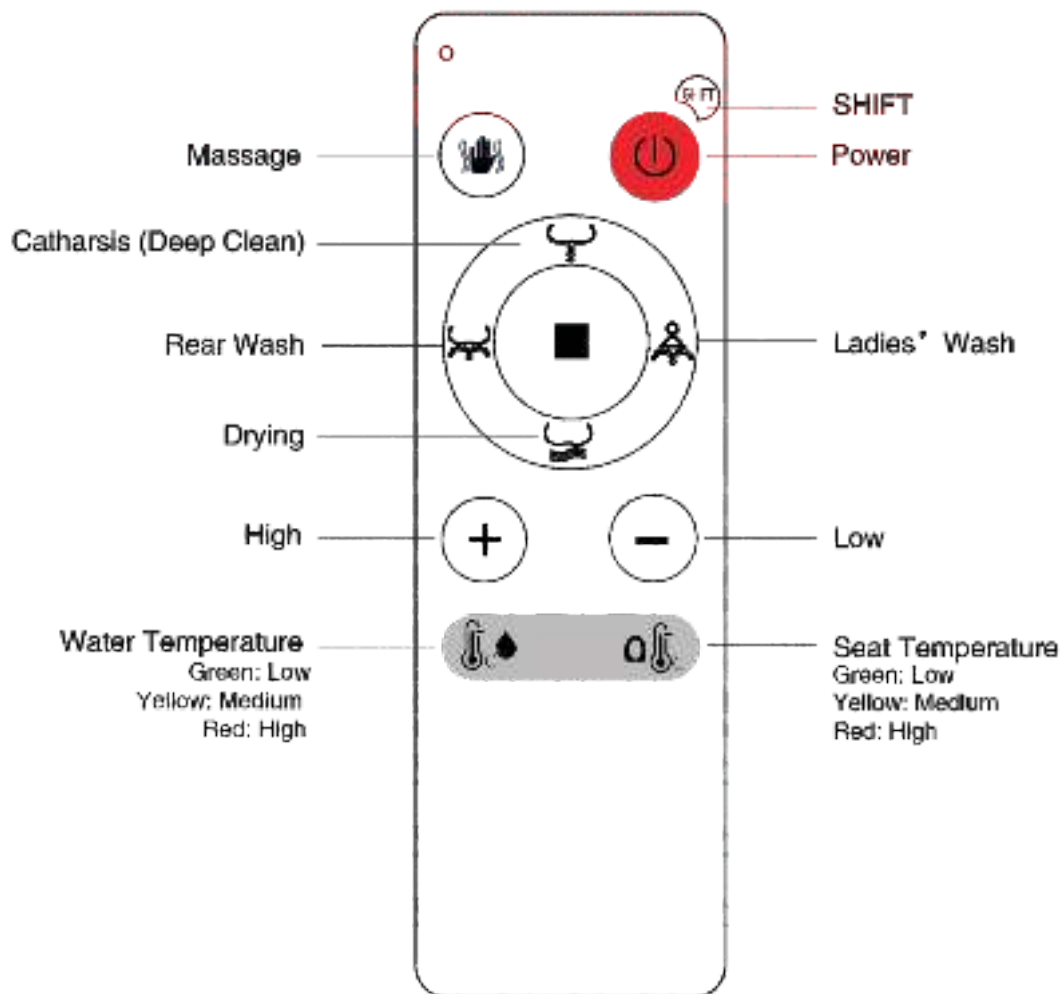

User Manual

# PARTS & ACCESSORIES



## Key Combinations

SHIFT + 	The nozzle will stretch out.
SHIFT + 	Deodorization
SHIFT +  (Short Press)	Massage will be memorized.
SHIFT +  (Long Press)	Nozzle Oscillation will be memorized.
+ (Long Press)	The nozzle will move forward.
- (Long Press)	The nozzle will move backward.
 (Long Press) = Nozzle Oscillation	The nozzle will shuttle back and forth automatically.

# INSTALLATION



## CAUTION



While this bidet is easy to install, you are strongly advised to use a qualified professional for a hitch-free installation and subsequent utilization.  
DO NOT CONNECT TO A POWER SOURCE UNTIL THE INSTALLATION HAS BEEN COMPLETED.

1

Turn off the water inlet valve and empty out the toilet's water tank (cistern).

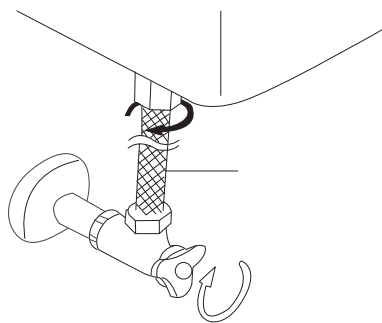

Use a suitable spanner to dismantle the original potable water hose.

2

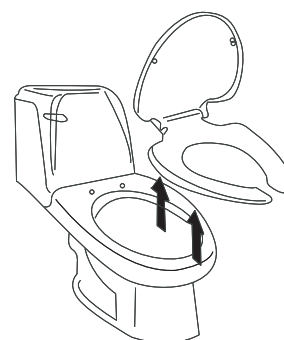

Remove the existing toilet seat and cover by undoing the mounting nuts and bolts.

3

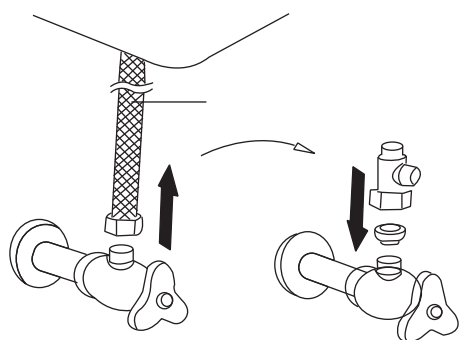

Connect the triple valve (T-valve) to the inlet valve. Do not use excessive force when tightening the nuts.

4

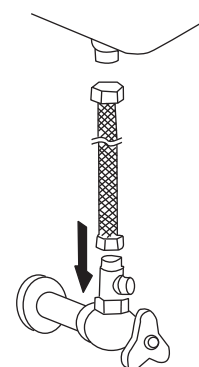

Use the potable water hose to connect the triple valve to the water tank.

# INSTALLATION

**5**

Insert the rubber bushings into the 2 holes of the toilet, as shown.

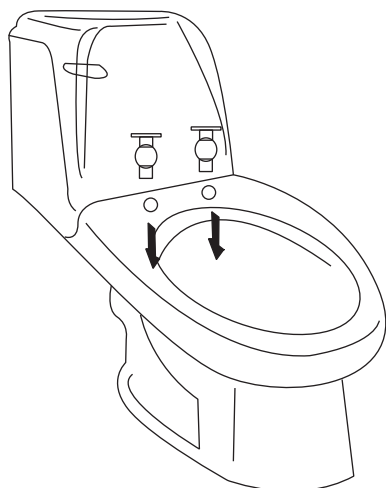

**6**

Position the mounting bracket on the toilet, just where the rubber bushings are.

Pass the mounting bolts through the regulating plates and then into the rubber bushings (through the openings of the mounting bracket) – using the metal washers as required.

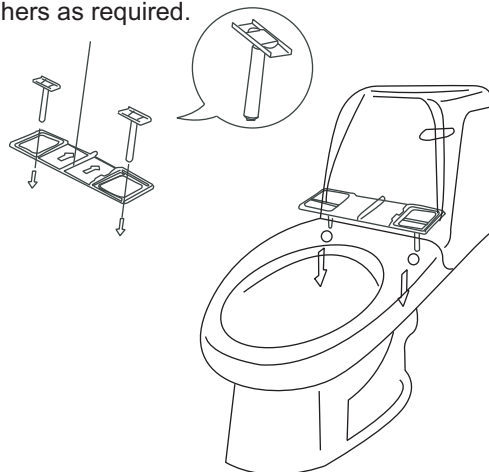

**7**

Place the bidet on the toilet and carefully position it so that you can then slide it forward, into the groves of the mounting bracket, until it locks. You will hear a clicking sound when this happens. If not, please press the Unlock button on the right side, pull the bidet towards you and repeat the process.

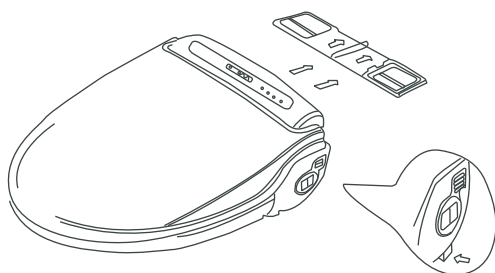

Lock/Unlock button

**8**

Connect the filter(optional) to the T-valve and then connect one end of the water hose to the filter. Open the inlet valve slightly until the water starts to flow out of the water hose and then close the inlet valve. Now connect the open end of the hose to the bidet.

Your water connection has now been completed!

**NB:** The filter is useful for personal hygiene purposes and to keep the appliance clean and functioning well. However, you will need to replace it every few months – depending on the quality of water supply and on the usage.

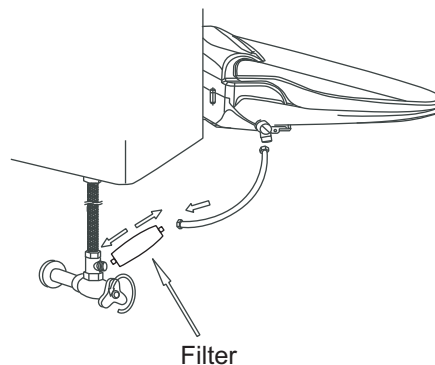

**Connect the power cord to electricity supply and you are all set to start enjoying your new smart bidet!**



# USING THE BIDET

## SITTING ON THE TOILET SEAT

When seated, the Occupied Sensor indicator lights up on the rear Indicator Panel and, at the same time, you can hear a short beep.

The Deodorization function also starts up automatically and will keep working until 1 minute after you stand up.

For the first use, set the water temperature, and water pressure, to the lowest positions as explained below. After using any wash function, you will be able to set the temperature, to your preferred level, for future use. The water pressure can be adjusted at any time whereas the water temperature increase, or decrease, takes a very short time to be attained.

## WASH CONTROLS:

### REAR WASH

This button starts the water spray for the usual cleaning of the anal zone. The water is mixed with a little air which creates a soft feel. At this time, it is advisable to set all parameters for your comfort (nozzle position, water temperature and water pressure). You should then press the Oscillate button so that the back and forth movement, of the nozzle, will result in a larger area being cleaned. The Massage function is also useful during this rear wash – either on its own or along with the Oscillate function.

### LADIES' WASH

This button starts a gentle and lukewarm spray onto the feminine zone. The temperature and pressure can be adjusted to comfortable levels. The Oscillate and the Massage functions are also useable and useful for this type of wash.

### CATHARSIS WASH (Deep Clean)

This function is to assist in evacuating residual faeces from the rectum.

First set the water pressure on low and then press the Catharsis button. A focused spray is directed at the anus. Adjust your seated position, and the water pressure, to ensure that the jet of water can penetrate through the anus without any water splashing, pain or discomfort. As soon as you feel that the rectum is getting full, press the stop button. The water softens the faeces thereby enabling it to be released more easily.

## STOP BUTTON

All above wash and dry functions will stop as soon as All this button is pressed.

## MESSAGE

Pressing this button during the WASH functions creates a massaging effect by alternating the spray strength between high and low.

The water massage pulsation strength can be adjusted by using the High and Low buttons. The water pressure will return to the starting mode if you press the Massage button once again.

## OSCILLATE

By pressing this button, the nozzle will shuttle back and forth 12mm, thereby enlarging the cleaning area in the REAR and LADIES' WASH functions.

You can adjust the oscillating scope by pressing the arrow buttons (←or→).

The nozzle will stop moving if you press the Oscillate button once again when it is moving.

## Extra Take care:

### DRY

By pressing this button, gusts of warm air will come out to dry wet part(s).

You can adjust the air temperature by pressing the High and Low buttons.

## WATER PRESSURE

Generally, you can control the water pressure by pressing the High and Low buttons – of course, when you are seated on the toilet seat. However, if you wish for the level to be memorised, press the Massage button for 3 seconds and it will set the pressure at the lowest level. If you press the Massage button again for another 3 seconds, the water pressure level will be memorised at the medium level. Pressing the Massage button yet again for 3 seconds, the pressure returns to the lowest level. You will notice the appropriate pressure level indicator, on the control panel, lights up during each of the above steps.

# USING THE BIDET

## NOZZLE POSITION

The nozzle moves forward & backward along a length of 12mm. The arrow buttons ( ←or→ ) enable you to select from a choice of 5 different nozzle positions to suit your convenience.

## WATER TEMPERATURE

At the starting stage, the temperature is in the off position. Therefore, the temperature of the water, in the bidet's own tank, would be either the room temperature or that of the water supply.

By pressing the WATER Temperature button, the Temperature indicator's green light comes on and the water temperature rises to 34°C/93. 2°F. By pressing the button again, the yellow light comes on and the temperature stabilises at 37°C/98. 6°F. Pressing the button, once again, makes the red light come on and the temperature climb to 40°C/104°F. The same cycle is repeated with every press of the button.

## SEAT TEMPERATURE

By pressing the SEAT Temperature button, the Temperature indicator's green light comes on and the seat temperature will rise to 34°C/93. 2°F. By pressing this button again, the yellow light comes on and the temperature will climb to 38°C/100. 4°F. Pressing the button, once again, makes the red light come on and the temperature will be at 41°C/105. 8°F. The same cycle is repeated with every press of the button.

the seat temperature will rise to 34°C/93. 2°F. By pressing this button again, the yellow light comes on and the temperature will climb to 38°C/100. 4°F. Pressing the button, once again, makes the red light come on and the temperature will be at 41°C/105. 8°F. The same cycle is repeated with every press of the button.

## POWER SAVER

When you press the Power Saver button, the Power Saving 1 indicator lights up on the rear Indicator Panel. In this function, the power saving is significant since the water heating will stop and will restart after 8 hours.

Pressing the button a 2<sup>nd</sup> time, starts the Power Saving 2 function. This is an "Eco Mode" with constant low power consumption. Here, the water and seat temperature are kept at about 32°C(89. 6°F) .If you press the button a 3<sup>rd</sup> time, the Power Saver function gets switched off.

If the Power Saving function is in use, it will temporarily stop when someone sits on the bidet.

The function will resume as soon as the user stands up.

## UV ANTIBACTERIAL LED & NIGHT LIGHT

The germicidal quality of the Ultra-Violet light, emitted by this long-life LED, helps to keep your toilet free from certain germs/bacteria.

The UV LED switches on when the bidet seat is occupied; It switches off when the user stands up.

The led also turns on automatically, when it becomes dark in the toilet area, thereby creating a clean toilet environment. A separate blue LED is installed to serve as a very convenient night light. This light is soft and soothing and, at night, the normal room/toilet light, which could disturb you/others, may not be necessary.

These LEDs can also be manually switched on and off by simultaneously pressing the STOP and WATER buttons.

## DEODORISER

This device is extremely useful in eliminating odours from the toilet bowl area. It has a motor which expels air (and odour), from that area, and deodorises it as it passes out of the vents on the side of the bidet.

This deodoriser function starts automatically as soon as the user sits on the toilet seat. It will continue to work for 1 minute after the user stands up. (Please see page 8 for further information.)

**Not only Use of this function but the maintenance of Nozzles and Deodoriser is equally important**

# MAINTENANCE

## NOZZLE

Firstly, ensure that there is no object on the seat's Seat Occupied Sensor and that you are also not seated on the bidet. Press the Rear Wash button for 3 seconds and the Nozzle will stretch out. Use a toothbrush to clean any dirt or stains that may have settled on the nozzle.

Press the Rear Wash button again to return the nozzle to its normal covered position.

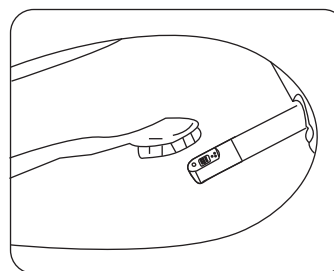

## DEODORISER

If you notice a drop in the performance of the deodoriser, pull out the deodorising cartridge, as shown, and, using a soft toothbrush, gently brush off any dust or dirt that may have collected on the cartridge. After about 6 months of routine cleaning, if you feel it is no longer working, remove the cartridge and expose it to direct sunlight for 2 to 3 hours. This should reactivate the carbon and allow further use. At some stage, After many years of average bidet use, you may have to replace it due to it having reached its natural expiry.

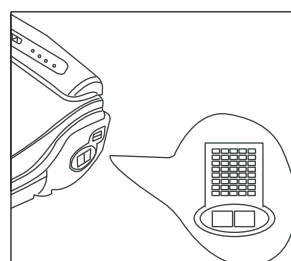

# SPECIFICATIONS

Rated Input Power	Voltage/ Frequency	110V(220V)/60HZ(50HZ)					
	Rated Input Power	660W					
Warm Seat	Seat Temperature	4 Levels: Off ( Room temp.), Low (34°C/93.2°F), Medium (38°C/100.4°F), High (41°C/105.8°F)					
	Safety Device	Temperature Inductor & Temperature Fuse					
Deodorizer	Deodorant	Activated	/	Activated	Activated	/	/
	Air Suction	0.1m <sup>3</sup> /min	/	0.1m <sup>3</sup> /min	0.1m <sup>3</sup> /min	/	/
Wash Function	Maximum Flow Rate	1.5L/Min					
	Pressure Adjustment	5 States					
	Water Temperature	4 Levels: Off ( Inflow/Room temp.), Low (34°C/93.2°F), Medium (37°C/98.6°F), High(40°C/104°F)					
	Warm Water Volume	1.2L Stored in the Tank					
Dryer	Safety Device	Temperature Inductor, Temperature Limiter & Temperature Fuse					
	Blowing Rate	/	0.25m <sup>3</sup> /min				
	Temperature Adjustable	/	5 States				
Water Nozzle	Safety Device	/	Temperature Limiter & Temperature Fuse				
	Back & Forth Function	Motor drive					
	Position Selection	Five Adjustable States					
	Oscillating Distance	The Nozzle Moves Forward & Backward along a Length of 12mm					
Other Safety Devices		Electricity Leakage Protector, Body Sensor & Seat Damper					
Range of Inlet Water Temperature		0°C ~ 40°C/32 ~ 104°F					
Range of Inlet Water Pressure		0.04 ~ 0.75Mpa					
Packing Size: L×W×H		560×520×230mm/24.5×22.0×9.1in					
Gross Weight		Approx. 7.4kg/16.3lb (Small Size); 7.6kg/17.2lb (Large Size)					

## TROUBLE-SHOOTING

Symptom	Possible Cause/Remedy
Bidet does not operate at all.	The bidet works only when the seat is sat on or if an object is placed on the Occupied sensor. Remove the plug from the socket and then re-plug it.
Water does not spray out.	The water inflow valve is closed. The filter is clogged.
Water Pressure is low.	Check the pressure setting or if the water filter is clogged.
Spray water is not warm.	Check the water temperature settings. Either the wash functions were used for a long time or the Power Saving 1 was on. It takes about 2 minutes for the water to re-heat.
Water leaking near the seat.	If the bidet appears not to be well-installed, carefully re-install it (see page 5).
The Buzzer Alarm is on.	Water tank is short of water. Check if inflow valve is open. If there's a temporary stoppage of house water supply, switch off the appliance and wait for the supply to return.
Deodoriser's fan works non-stop.	Check if there is anything covering the Occupied seat sensor.

## DISMANTLING THE BIDET

If you need to remove the bidet for cleaning purpose, or for sending to the service centre, please:

1. Remove the plug from the power socket and
2. Cut off the water supply by turning the valve clockwise. Disconnect the hose from the bidet.
3. Press the button on the side of the bidet, as shown, to completely empty out the water tank.
4. Press again the side button and slide out the bidet by pulling it towards you as shown.

The button on the right side of the seat is to be used for draining out the water and also for unlocking the bidet from the mounting plate.

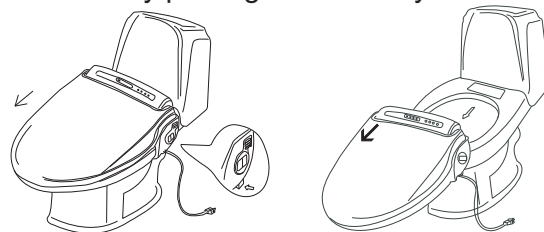

**NOTE:** If you are removing the bidet to install it elsewhere, then continue with the following steps:

5. Remove the T-valve, the water filter and the hose that connects the filter to the bidet. Empty out the water from the filter and hose.
6. Re-fix the original water inlet hose from the valve directly to the water tank (cistern) of the toilet. Turn on the water supply by turning the valve anti-clockwise.

**CAUTION:** Do not use excessive force when tightening the nuts of the hose with your spanner.

# WARRANTY CARD

## SMART BIDET

**Model No:**

**Serial No:**

**Date of Purchase:**

### TERMS AND CONDITIONS

Please send a copy of the completed form, to the nearest service centre, retaining the original with you. This is to avoid any unnecessary difficulties regarding the eligibility of warranty.

For availing service under this limited warranty, the service centre will advise you if the repair/ service will be carried out at your premises or the product needs to be brought to the service centre. You need to produce this form along with original purchase invoice.

This purchase is warranted against defects in material and workmanship for a period of 1 year from the date of first purchase from an authorized dealer, subject to correct installation and use.

This warranty is not valid in the event of a resale and the rights hereunder are not assignable. During the warranty period, the Company's service center will provide Service and replacement of only those materials with ex-factory defects. While the Company will make best efforts to repair as early as possible, it is expressly stated here that no time period is set for such a repair.

This warranty will not apply to any failure of the product due to improper maintenance, misuse, abuse, repairs/maintenance by unauthorised agency, tampering, etc. Damage to, and alteration/ removal of, the serial number will result in the warranty being null and void.

This warranty is not applicable to any damage due to fire, natural disasters, acts of war and public disturbances.



Jaaz Corporation Pvt. Ltd.

406 Onyx, Akshar Cross Road,  
O.P. Road,  
Vadodara-390020  
Gujarat,  
India.

Service Contact No: +91 9408630765

### Customer's Details

Name :

Address:

Tel. No.:

Signature: